



Jeunes Talents de l'Est (JTE)



RIBEAUVILLE du 11/05/2008 au 11/05/2008

Classement Officiel

BENJAMINES DAMES ARC CLASSIQUE

| Clt | Nom | Club | Licence | Cat. | S1 | S2 | S3 | S4 | Total | Nb10 | Nb 10+ |
|-----|---------------|----------------|---------|------|-----|-----|----|----|-------|------|--------|
| 1 | MEYER PERRINE | BRUNSTATT | 698908H | BFCL | 291 | 297 | | | 588 | | |
| 2 | MAIRE MARINE | BRUNSTATT | 623166E | BFCL | 286 | 286 | | | 572 | | |
| 3 | FISHER NADEGE | STIRING-WENDEL | 656001V | BFCL | 257 | 267 | | | 524 | | |

Nombre d'archers 3

BENJAMINS HOMMES ARC CLASSIQUE

| Clt | Nom | Club | Licence | Cat. | S1 | S2 | S3 | S4 | Total | Nb10 | Nb 10+ |
|-----|-----------------------|----------------|---------|------|-----|-----|----|----|-------|------|--------|
| 1 | TOMBUL ALEXIS | STIRING-WENDEL | 630440L | BHCL | 287 | 302 | | | 589 | | |
| 2 | TOMBUL FLORIAN | STIRING-WENDEL | 630439K | BHCL | 308 | 274 | | | 582 | | |
| 3 | GERHARDT SYLVAIN | NEUVES MAISONS | 621062T | BHCL | 283 | 266 | | | 549 | | |
| 4 | HATTENBERGER GREGOIRE | BRUNSTATT | 691585Y | BHCL | 230 | 245 | | | 475 | | |

Nombre d'archers 4

MINIMES DAMES ARC CLASSIQUE

| Clt | Nom | Club | Licence | Cat. | S1 | S2 | S3 | S4 | Total | Nb10 | Nb 10+ |
|-----|--------------------|--------------------|---------|------|-----|-----|----|----|-------|------|--------|
| 1 | THOMAS SOLENE | COLMAR | 668109F | MFCL | 309 | 287 | | | 596 | | |
| 2 | SCHEPPERS MADISON | TOUL | 626420S | MFCL | 294 | 274 | | | 568 | 4 | 2 |
| 3 | SCHEPPERS LUCREZIA | TOUL | 626419R | MFCL | 282 | 286 | | | 568 | 3 | 2 |
| 4 | QUAIA LUCIE | STIRING-WENDEL | 630438J | MFCL | 280 | 277 | | | 557 | 4 | 1 |
| 5 | MILLOT ELODIE | SEICHAMPS | 703311U | MFCL | 261 | 296 | | | 557 | 3 | 2 |
| 6 | SIXTO VICTORIA | STRASBOURG 1ER CIE | 681973A | MFCL | 281 | 275 | | | 556 | | |
| 7 | BUEB ANAIS | STRASBOURG 1ER CIE | 689278R | MFCL | 241 | 238 | | | 479 | | |
| 8 | DUGON LOUISE | STRASBOURG 1ER CIE | 682025G | MFCL | 182 | 227 | | | 409 | | |
| 9 | KLEIN LORRAINE | STRASBOURG 1ER CIE | 637489Y | MFCL | 141 | 200 | | | 341 | | |
| 10 | BERTHOLD CLEMENCE | BRUNSTATT | 710899S | MFCL | 168 | 149 | | | 317 | | |

Nombre d'archers 10

MINIMES HOMMES ARC CLASSIQUE

| Clt | Nom | Club | Licence | Cat. | S1 | S2 | S3 | S4 | Total | Nb10 | Nb 10+ |
|-----|-----------------------|----------------|---------|------|-----|-----|----|----|-------|------|--------|
| 1 | SCARANO NINO | SEICHAMPS | 624556R | MHCL | 324 | 328 | | | 652 | | |
| 2 | ANTOINE THOMAS | PONT A MOUSSON | 443819M | MHCL | 309 | 310 | | | 619 | | |
| 3 | BITSCH LUCAS | BRUNSTATT | 452408Y | MHCL | 288 | 286 | | | 574 | 5 | 1 |
| 4 | ANDRIANARISON CAMILLE | TORPES | 661949K | MHCL | 295 | 279 | | | 574 | | |
| 5 | GIUJUZZA VICTOR | FROUARD | 632624K | MHCL | 268 | 270 | | | 538 | | |

| | | | | | | | | | | | |
|----|--------------------|----------------------|---------|------|-----|-----|--|--|-----|--|--|
| 6 | FISCHER CLEMENT | BRUNSTATT | 605968L | MHCL | 246 | 269 | | | 515 | | |
| 7 | BIHR MARTIN | TORPES | 661963A | MHCL | 263 | 248 | | | 511 | | |
| 8 | CAISSUTTI LEO | STRASBOURG 1ER CIE | 662282X | MHCL | 255 | 226 | | | 481 | | |
| 9 | MARTOUZET GREGOIRE | BRUNSTATT | 622707F | MHCL | 233 | 242 | | | 475 | | |
| 10 | RAVAUX CHRISTOPHE | CHARLEVILLE MEZIERES | 594539N | MHCL | 220 | 247 | | | 467 | | |
| 11 | WOLFF THOMAS | STRASBOURG 1ER CIE | 604837G | MHCL | 234 | 221 | | | 455 | | |
| 12 | SCHUSTER ANTOINE | STRASBOURG 1ER CIE | 664973X | MHCL | 229 | 210 | | | 439 | | |
| 13 | JOSSERAND JONATHAN | STRASBOURG 1ER CIE | 462887N | MHCL | 197 | 194 | | | 391 | | |
| 14 | POTDEVIN JULIEN | LIGNY EN BARROIS | 680522Y | MHCL | 199 | 132 | | | 331 | | |

Nombre d'archers 14

CADETTES DAMES ARC CLASSIQUE

| Cl | Nom | Club | Licence | Cat. | S1 | S2 | S3 | S4 | Total | Nb10 | Nb 10+ |
|----|--------------------|--------------------|---------|------|-----|-----|----|----|-------|------|--------|
| 1 | SCHENCKBECHER EMMA | BRUNSTATT | 623167F | CFCL | 258 | 257 | | | 515 | | |
| 2 | DURRENBERGER INES | STRASBOURG 1ER CIE | 624773B | CFCL | 260 | 232 | | | 492 | | |
| 3 | KENNER AUDREY | COLMAR | 593517C | CFCL | 215 | 239 | | | 454 | | |
| 4 | CUVILLIER AMANDINE | ST NICOLAS DE PORT | 613765L | CFCL | 170 | 226 | | | 396 | | |
| 5 | GASCHY FANNY | VOLGELSHEIM | 623675H | CFCL | 217 | 173 | | | 390 | | |
| 6 | MEYER NOEMIE | BRUNSTATT | 618888E | CFCL | 167 | 187 | | | 354 | | |
| 7 | COUDRIET LAURANE | STRASBOURG 1ER CIE | 653148U | CFCL | 177 | 169 | | | 346 | | |

Nombre d'archers 7

CADETS HOMMES ARC CLASSIQUE

| Cl | Nom | Club | Licence | Cat. | S1 | S2 | S3 | S4 | Total | Nb10 | Nb 10+ |
|----|-------------------|--------------------|---------|------|-----|-----|----|----|-------|------|--------|
| 1 | GOUJON LOIK | NANCY | 636634U | CHCL | 273 | 287 | | | 560 | | |
| 2 | JOUBERT VALENTIN | THAON LES VOSGES | 631021T | CHCL | 258 | 277 | | | 535 | | |
| 3 | MATHEY ROBIN | TORPES | 661954R | CHCL | 257 | 252 | | | 509 | | |
| 4 | LOHR QUENTIN | BUHL | 466520M | CHCL | 237 | 269 | | | 506 | | |
| 5 | BLANCO ROMAIN | PONT A MOUSSON | 596123K | CHCL | 254 | 227 | | | 481 | | |
| 6 | CASERY ALAN | ST LUPICIN | 624324N | CHCL | 208 | 266 | | | 474 | | |
| 7 | SCANDONE ANTHONY | FOLSCHVILLER | 623556D | CHCL | 232 | 228 | | | 460 | | |
| 8 | LAEMMEL LEO | STRASBOURG 1ER CIE | 594790L | CHCL | 222 | 221 | | | 443 | | |
| 9 | BOILEAU JULIEN | RETHEL | 638158A | CHCL | 220 | 216 | | | 436 | | |
| 10 | COLLIGNON DAVID | VERTUS | 639130G | CHCL | 197 | 227 | | | 424 | | |
| 11 | KILLOFFER MICHEL | NEUVES MAISONS | 454485F | CHCL | 214 | 209 | | | 423 | | |
| 12 | GERARD GUILLAUME | VOLGELSHEIM | 632337Y | CHCL | 232 | 181 | | | 413 | 3 | 1 |
| 13 | MUNSCH PHILIPPE | BRUNSTATT | 616324T | CHCL | 203 | 200 | | | 403 | | |
| 14 | FLOQUET NICOLAS | STRASBOURG 1ER CIE | 682020B | CHCL | 168 | 234 | | | 402 | | |
| 15 | LEROY FLORENT | COLMAR | 613545X | CHCL | 211 | 188 | | | 399 | | |
| 16 | BOESCHLIN NICOLAS | STRASBOURG 1ER CIE | 452181B | CHCL | 174 | 188 | | | 362 | | |

| | | | | | | | | | | | |
|----|------------------|--------------------|---------|------|-----|-----|--|--|-----|---|---|
| 17 | LEPAGE ALEXANDRE | BRUNSTATT | 665046B | CHCL | 191 | 163 | | | 354 | | |
| 18 | REINHARDT GILLOU | STRASBOURG 1ER CIE | 661556H | CHCL | 166 | 185 | | | 351 | | |
| 19 | VUILLERMOZ ABEL | LIGNY EN BARROIS | 633087N | CHCL | 166 | 169 | | | 335 | 1 | 1 |
| 20 | ROMANO ANTONIN | MUNSTER | 644203W | CHCL | 167 | 139 | | | 306 | | |
| 21 | LEROUX DUNCAN | STRASBOURG 1ER CIE | 594791M | CHCL | 158 | 133 | | | 291 | | |
| 22 | MATHIEU JEREMIE | COLMAR | 613540S | CHCL | 92 | 164 | | | 256 | | |
| 23 | HUSSER FREDERIC | MUNSTER | 658307B | CHCL | 122 | 102 | | | 224 | | |

Nombre d'archers 23

JUNIORS DAMES ARC CLASSIQUE

| Clt | Nom | Club | Licence | Cat. | S1 | S2 | S3 | S4 | Total | Nb10 | Nb 10+ |
|-----|--------------------|------------------|---------|------|-----|-----|----|----|-------|------|--------|
| 1 | LABBE MARION | HAGUENAU | 615430W | JFCL | 241 | 251 | | | 492 | | |
| 2 | FACANAT JULIETTE | SEICHAMPS | 623271U | JFCL | 249 | 231 | | | 480 | | |
| 3 | CHOLLEY MATHILDE | TORPES | 443181U | JFCL | 161 | 211 | | | 372 | | |
| 4 | GUINCHARD EMILIE | TORPES | 443174L | JFCL | 175 | 143 | | | 318 | | |
| 5 | PERREAU ANTOINETTE | LIGNY EN BARROIS | 680662A | JFCL | 104 | 66 | | | 170 | | |

Nombre d'archers 5

JUNIORS HOMMES CLASSIQUE

| Clt | Nom | Club | Licence | Cat. | S1 | S2 | S3 | S4 | Total | Nb10 | Nb 10+ |
|-----|--------------------|----------------------|---------|------|-----|-----|----|----|-------|------|--------|
| 1 | THIEBAUT MATHIEU | TORPES | 597127B | JHCL | 298 | 292 | | | 590 | | |
| 2 | KETTERER HUGO | STRASBOURG 1ER CIE | 438136K | JHCL | 294 | 285 | | | 579 | | |
| 3 | BENEDIC JOFFREY | THAON LES VOSGES | 618722Z | JHCL | 297 | 277 | | | 574 | | |
| 4 | SCHMITT ESTEBAN | NEUVES MAISONS | 460801W | JHCL | 274 | 280 | | | 554 | | |
| 5 | KETTERER THIBAUT | BUHL | 614869L | JHCL | 256 | 253 | | | 509 | | |
| 6 | MARTOUZET AUGUSTIN | BRUNSTATT | 622706E | JHCL | 249 | 259 | | | 508 | | |
| 7 | DANTEC CORENTIN | STRASBOURG 1ER CIE | 608258A | JHCL | 226 | 226 | | | 452 | | |
| 8 | BEVIERE AURELIEN | CHARLEVILLE MEZIERES | 628428Z | JHCL | 220 | 202 | | | 422 | | |
| 9 | BRAULT ROMAIN | BRUNSTATT | 636040Y | JHCL | 178 | 201 | | | 379 | | |

Nombre d'archers 9

JUNIORS HOMMES ARC A POULIES

| Clt | Nom | Club | Licence | Cat. | S1 | S2 | S3 | S4 | Total | Nb10 | Nb 10+ |
|-----|-----------------------|--------------------|---------|------|-----|-----|----|----|-------|------|--------|
| 1 | FARAH MOHAMED | BRUNSTATT | 608327A | JHCO | 306 | 301 | | | 607 | | |
| 2 | LUX CHRISTOPHE | HAGUENAU | 694770K | JHCO | 239 | 230 | | | 469 | | |
| 3 | CHRIST-BERTRAND JOHAN | HAGUENAU | 686492M | CHCO | 244 | 217 | | | 461 | | |
| 4 | JAMEAU ALEXANDRE | FROUARD | 625477S | CHCO | 227 | 215 | | | 442 | | |
| 5 | MULLER PIERRE | STRASBOURG 1ER CIE | 590366C | JHCO | 220 | 163 | | | 383 | | |

Nombre d'archers 5

Nombre total d'archers 80

Club Organisateur

3168015 RIBEAUVILLE (RIBEAUPIERRE)

Arbitre Responsable

M. BURGLEN BERNARD

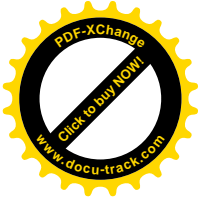
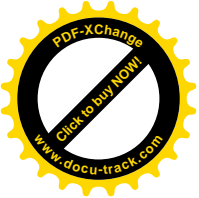

Tirs de qualifications

BENJAMINES DAMES ARC CLASSIQUE

| Cl | Nom | Club | Licence | Cat. | S1 | S2 | |
|----|---------------|----------------|---------|------|-----|-----|-----|
| 1 | MEYER PERRINE | BRUNSTATT | 698908H | BFCL | 291 | 297 | 588 |
| 2 | MAIRE MARINE | BRUNSTATT | 623166E | BFCL | 286 | 286 | 572 |
| 3 | FISHER NADEGE | STIRING-WENDEL | 656001V | BFCL | 257 | 267 | 524 |

BENJAMINS HOMMES ARC CLASSIQUE

| Cl | Nom | Club | Licence | Cat. | S1 | S2 | |
|----|-----------------------|----------------|---------|------|-----|-----|-----|
| 1 | TOMBUL ALEXIS | STIRING-WENDEL | 630440L | BHCL | 287 | 302 | 589 |
| 2 | TOMBUL FLORIAN | STIRING-WENDEL | 630439K | BHCL | 308 | 274 | 582 |
| 3 | GERHARDT SYLVAIN | NEUVES MAISONS | 621062T | BHCL | 283 | 266 | 549 |
| 4 | HATTENBERGER GREGOIRE | BRUNSTATT | 691585Y | BHCL | 230 | 245 | 475 |

MINIMES DAMES ARC CLASSIQUE

| Cl | Nom | Club | Licence | Cat. | S1 | S2 | |
|----|--------------------|--------------------|---------|------|-----|-----|-----|
| 1 | THOMAS SOLENE | COLMAR | 668109F | MFCL | 309 | 287 | 596 |
| 2 | SCHEPPERS MADISON | TOUL | 626420S | MFCL | 294 | 274 | 568 |
| 3 | SCHEPPERS LUCREZIA | TOUL | 626419R | MFCL | 282 | 286 | 568 |
| 4 | QUAIA LUCIE | STIRING-WENDEL | 630438J | MFCL | 280 | 277 | 557 |
| 5 | MILLOT ELODIE | SEICHAMPS | 703311U | MFCL | 261 | 296 | 557 |
| 6 | SIXTO VICTORIA | STRASBOURG 1ER CIE | 681973A | MFCL | 281 | 275 | 556 |
| 7 | BUEB ANAIS | STRASBOURG 1ER CIE | 689278R | MFCL | 241 | 238 | 479 |
| 8 | DUGON LOUISE | STRASBOURG 1ER CIE | 682025G | MFCL | 182 | 227 | 409 |
| 9 | KLEIN LORRAINE | STRASBOURG 1ER CIE | 637489Y | MFCL | 141 | 200 | 341 |
| 10 | BERTHOLD CLEMENCE | BRUNSTATT | 710899S | MFCL | 168 | 149 | 317 |

MINIMES HOMMES ARC CLASSIQUE

| Cl | Nom | Club | Licence | Cat. | S1 | S2 | |
|----|-----------------------|----------------------|---------|------|-----|-----|-----|
| 1 | SCARANO NINO | SEICHAMPS | 624556R | MHCL | 324 | 328 | 652 |
| 2 | ANTOINE THOMAS | PONT A MOUSSON | 443819M | MHCL | 309 | 310 | 619 |
| 3 | BITSCH LUCAS | BRUNSTATT | 452408Y | MHCL | 288 | 286 | 574 |
| 4 | ANDRIANARISON CAMILLE | TORPES | 661949K | MHCL | 295 | 279 | 574 |
| 5 | GIUJUZZA VICTOR | FROUARD | 632624K | MHCL | 268 | 270 | 538 |
| 6 | FISCHER CLEMENT | BRUNSTATT | 605968L | MHCL | 246 | 269 | 515 |
| 7 | BIHR MARTIN | TORPES | 661963A | MHCL | 263 | 248 | 511 |
| 8 | CAISSUTTI LEO | STRASBOURG 1ER CIE | 662282X | MHCL | 255 | 226 | 481 |
| 9 | MARTOUZET GREGOIRE | BRUNSTATT | 622707F | MHCL | 233 | 242 | 475 |
| 10 | RAVAUX CHRISTOPHE | CHARLEVILLE MEZIERES | 594539N | MHCL | 220 | 247 | 467 |
| 11 | WOLFF THOMAS | STRASBOURG 1ER CIE | 604837G | MHCL | 234 | 221 | 455 |
| 12 | SCHUSTER ANTOINE | STRASBOURG 1ER CIE | 664973X | MHCL | 229 | 210 | 439 |
| 13 | JOSSERAND JONATHAN | STRASBOURG 1ER CIE | 462887N | MHCL | 197 | 194 | 391 |
| 14 | POTDEVIN JULIEN | LIGNY EN BARROIS | 680522Y | MHCL | 199 | 132 | 331 |

CADETTES-JUNIORS DAMES ARC CLASSIQUE

| Cl | Nom | Club | Licence | Cat. | S1 | S2 | |
|----|--------------------|--------------------|---------|------|-----|-----|-----|
| 1 | SCHENCKBECHER EMMA | BRUNSTATT | 623167F | CFCL | 258 | 257 | 515 |
| 2 | DURRENBERGER INES | STRASBOURG 1ER CIE | 624773B | CFCL | 260 | 232 | 492 |
| 3 | LABBE MARION | HAGUENAU | 615430W | JFCL | 241 | 251 | 492 |
| 4 | FACANAT JULIETTE | SEICHAMPS | 623271U | JFCL | 249 | 231 | 480 |
| 5 | KENNER AUDREY | COLMAR | 593517C | CFCL | 215 | 239 | 454 |
| 6 | CUVILLIER AMANDINE | ST NICOLAS DE PORT | 613765L | CFCL | 170 | 226 | 396 |
| 7 | GASCHY FANNY | VOLGELSHEIM | 623675H | CFCL | 217 | 173 | 390 |
| 8 | CHOLLEY MATHILDE | TORPES | 443181U | JFCL | 161 | 211 | 372 |

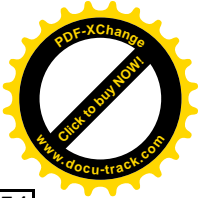
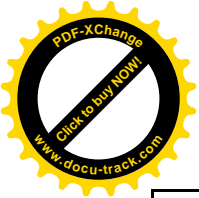

| | | | | | | | |
|----|--------------------|--------------------|---------|------|-----|-----|-----|
| 9 | MEYER NOEMIE | BRUNSTATT | 618888E | CFCL | 167 | 187 | 354 |
| 10 | COUDRIET LAURANE | STRASBOURG 1ER CIE | 653148U | CFCL | 177 | 169 | 346 |
| 11 | GUINCHARD EMILIE | TORPES | 443174L | JFCL | 175 | 143 | 318 |
| 12 | PERREAU ANTOINETTE | LIGNY EN BARROIS | 680662A | JFCL | 104 | 66 | 170 |

CADETS-JUNIORS HOMMES ARC CLASSIQUE

| Clt | Nom | Club | Licence | Cat. | S1 | S2 | |
|-----|--------------------|----------------------|---------|------|-----|-----|-----|
| 1 | THIEBAUT MATHIEU | TORPES | 597127B | JHCL | 298 | 292 | 590 |
| 2 | KETTERER HUGO | STRASBOURG 1ER CIE | 438136K | JHCL | 294 | 285 | 579 |
| 3 | BENEDIC JOFFREY | THAON LES VOSGES | 618722Z | JHCL | 297 | 277 | 574 |
| 4 | GOUJON LOIK | NANCY | 636634U | CHCL | 273 | 287 | 560 |
| 5 | SCHMITT ESTEBAN | NEUVES MAISONS | 460801W | JHCL | 274 | 280 | 554 |
| 6 | JOUBERT VALENTIN | THAON LES VOSGES | 631021T | CHCL | 258 | 277 | 535 |
| 7 | MATHEY ROBIN | TORPES | 661954R | CHCL | 257 | 252 | 509 |
| 8 | KETTERER THIBAUT | BUHL | 614869L | JHCL | 256 | 253 | 509 |
| 9 | MARTOUZET AUGUSTIN | BRUNSTATT | 622706E | JHCL | 249 | 259 | 508 |
| 10 | LOHR QUENTIN | BUHL | 466520M | CHCL | 237 | 269 | 506 |
| 11 | BLANCO ROMAIN | PONT A MOUSSON | 596123K | CHCL | 254 | 227 | 481 |
| 12 | CASERY ALAN | ST LUPICIN | 624324N | CHCL | 208 | 266 | 474 |
| 13 | SCANDONE ANTHONY | FOLSCHVILLER | 623556D | CHCL | 232 | 228 | 460 |
| 14 | DANTEC CORENTIN | STRASBOURG 1ER CIE | 608258A | JHCL | 226 | 226 | 452 |
| 15 | LAEMMEL LEO | STRASBOURG 1ER CIE | 594790L | CHCL | 222 | 221 | 443 |
| 16 | BOILEAU JULIEN | RETHEL | 638158A | CHCL | 220 | 216 | 436 |
| 17 | COLLIGNON DAVID | VERTUS | 639130G | CHCL | 197 | 227 | 424 |
| 18 | KILLOFFER MICHEL | NEUVES MAISONS | 454485F | CHCL | 214 | 209 | 423 |
| 19 | BEVIERE AURELIEN | CHARLEVILLE MEZIERES | 628428Z | JHCL | 220 | 202 | 422 |
| 20 | GERARD GUILLAUME | VOLGELSHEIM | 632337Y | CHCL | 232 | 181 | 413 |
| 21 | MUNSCH PHILIPPE | BRUNSTATT | 616324T | CHCL | 203 | 200 | 403 |
| 22 | FLOQUET NICOLAS | STRASBOURG 1ER CIE | 682020B | CHCL | 168 | 234 | 402 |
| 23 | LEROY FLORENT | COLMAR | 613545X | CHCL | 211 | 188 | 399 |
| 24 | BRAULT ROMAIN | BRUNSTATT | 636040Y | JHCL | 178 | 201 | 379 |
| 25 | BOESCHLIN NICOLAS | STRASBOURG 1ER CIE | 452181B | CHCL | 174 | 188 | 362 |
| 26 | LEPAGE ALEXANDRE | BRUNSTATT | 665046B | CHCL | 191 | 163 | 354 |
| 27 | REINHARDT GILLOU | STRASBOURG 1ER CIE | 661556H | CHCL | 166 | 185 | 351 |
| 28 | VUILLERMOZ ABEL | LIGNY EN BARROIS | 633087N | CHCL | 166 | 169 | 335 |
| 29 | ROMANO ANTONIN | MUNSTER | 644203W | CHCL | 167 | 139 | 306 |
| 30 | LEROUX DUNCAN | STRASBOURG 1ER CIE | 594791M | CHCL | 158 | 133 | 291 |
| 31 | MATHIEU JEREMIE | COLMAR | 613540S | CHCL | 92 | 164 | 256 |
| 32 | HUSSER FREDERIC | MUNSTER | 658307B | CHCL | 122 | 102 | 224 |

JUNIORS HOMMES ARC A POULIES

| Clt | Nom | Club | Licence | Cat. | S1 | S2 | |
|-----|-----------------------|--------------------|---------|------|-----|-----|-----|
| 1 | FARAH MOHAMED | BRUNSTATT | 608327A | JHCO | 306 | 301 | 607 |
| 2 | LUX CHRISTOPHE | HAGUENAU | 694770K | JHCO | 239 | 230 | 469 |
| 3 | CHRIST-BERTRAND JOHAN | HAGUENAU | 686492M | CHCO | 244 | 217 | 461 |
| 4 | JAMEAU ALEXANDRE | FROUARD | 625477S | CHCO | 227 | 215 | 442 |
| 5 | MULLER PIERRE | STRASBOURG 1ER CIE | 590366C | JHCO | 220 | 163 | 383 |

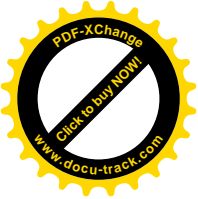

Minimes Filles Classiques

| Cible 5 | | Match 1 | | Match 2 | | Match 3 | | Totaux | | | |
|---------|---------------|----------|-------|----------|-------|----------|-------|--------|----------|-------|------------|
| Poule A | | Résultat | Score | Résultat | Score | Résultat | Score | Bonus | Résultat | Score | Classement |
| A | THOMAS SOLENE | 1 | 90 | 0 | 83 | 1 | 94 | 1 | 3 | 267 | 1 |
| B | QUAIA LUCIE | 0 | 71 | 0 | 72 | 1 | 94 | 1 | 2 | 237 | 3 |
| C | MILLOT ELODIE | 1 | 88 | 1 | 99 | 0 | 80 | 0 | 2 | 267 | 2 |
| D | DUGON LOUISE | 0 | 69 | 1 | 78 | 0 | 89 | 0 | 1 | 236 | 4 |

| Cible 6 | | Match 1 | | Match 2 | | Match 3 | | Totaux | | | |
|---------|--------------------|----------|-------|----------|-------|----------|-------|--------|----------|-------|------------|
| Poule B | | Résultat | Score | Résultat | Score | Résultat | Score | Bonus | Résultat | Score | Classement |
| A | SCHEPPERS MADISON | 1 | 101 | 1 | 97 | 1 | 98 | 1 | 4 | 296 | 1 |
| B | SCHEPPERS LUCREZIA | 0 | 83 | 1 | 100 | 0 | 97 | 1 | 2 | 280 | 3 |
| C | SIXTO VICTORIA | 1 | 97 | 0 | 95 | 1 | 106 | 0 | 2 | 298 | 2 |
| D | BUEB ANAIS | 0 | 78 | 0 | 93 | 0 | 87 | 0 | 0 | 258 | 4 |

| | | Match 1 | | Match 2 | | Match 3 | |
|----|---|---------|---|---------|---|---------|--|
| AB | A | B | A | C | A | D | |
| CD | C | D | B | D | B | C | |

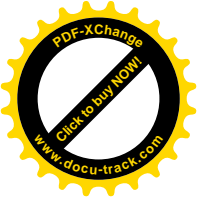

Minimes Hommes Classiques

| Cible 7 - AB | | Match 1 | | Match 2 | | Match 3 | | Totaux | | | |
|--------------|--------------------|----------|-------|----------|-------|----------|-------|--------|----------|-------|------------|
| Poule A | | Résultat | Score | Résultat | Score | Résultat | Score | Bonus | Résultat | Score | Classement |
| A | SCARANO NINO | 1 | 104 | 1 | 103 | 1 | | 1 | 4 | 207 | 1 |
| B | CAISSUTTI LEO | 0 | 82 | 1 | | 1 | 80 | 0 | 2 | 162 | 2 |
| C | MARTOUZET GREGOIRE | 1 | | 0 | 90 | 0 | 72 | 0 | 1 | 162 | 3 |

| Cible 7 - CD | | Match 1 | | Match 2 | | Match 3 | | Totaux | | | |
|--------------|-------------------|----------|-------|----------|-------|----------|-------|--------|----------|-------|------------|
| Poule B | | Résultat | Score | Résultat | Score | Résultat | Score | Bonus | Résultat | Score | Classement |
| A | ANTOINE THOMAS | 1 | 107 | 1 | 101 | 1 | | 1 | 4 | 208 | 1 |
| B | BIHR MARTIN | 0 | 95 | 1 | | 1 | 89 | 0 | 2 | 184 | 2 |
| C | RAVAUX CHRISTOPHE | 1 | | 0 | 79 | 0 | 81 | 0 | 1 | 160 | 3 |

| Cible 8 - AB | | Match 1 | | Match 2 | | Match 3 | | Totaux | | | |
|--------------|-----------------|----------|-------|----------|-------|----------|-------|--------|----------|-------|------------|
| Poule C | | Résultat | Score | Résultat | Score | Résultat | Score | Bonus | Résultat | Score | Classement |
| A | BITSCH LUCAS | 1 | 88 | 1 | 92 | 1 | | 1 | 4 | 180 | 1 |
| B | FISCHER CLEMENT | 0 | 83 | 1 | | 0 | 84 | 1 | 2 | 167 | 3 |
| C | WOLFF THOMAS | 1 | | 0 | 84 | 1 | 85 | 0 | 2 | 169 | 2 |

| Cible 8 - CD | | Match 1 | | Match 2 | | Match 3 | | Totaux | | | |
|--------------|-----------------------|----------|-------|----------|-------|----------|-------|--------|----------|-------|------------|
| Poule D | | Résultat | Score | Résultat | Score | Résultat | Score | Bonus | Résultat | Score | Classement |
| A | ANDRIANARISON CAMILLE | 1 | 97 | 1 | 100 | 1 | | 1 | 4 | 197 | 1 |
| B | GIUJUZZA VICTOR | 0 | 94 | 1 | | 1 | 96 | 1 | 3 | 190 | 2 |
| C | SCHUSTER ANTOINE | 1 | | 0 | 72 | 0 | 75 | 0 | 1 | 147 | 3 |

| Match 1 | | Match 2 | | Match 3 | |
|---------|---|---------|---|---------|---|
| A | B | A | C | B | C |
| C | | B | | A | |

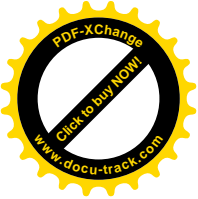

Cadettes et Juniors Femmes Classiques

| Cible 9 | | Match 1 | | Match 2 | | Match 3 | | Totaux | | | |
|---------|--------------------|----------|-------|----------|-------|----------|-------|--------|----------|-------|------------|
| Poule A | | Résultat | Score | Résultat | Score | Résultat | Score | Bonus | Résultat | Score | Classement |
| A | SCHENCKBECHER EMMA | 1 | 83 | 1 | 87 | 1 | | 1 | 4 | 170 | 1 |
| B | CHOLLEY MATHILDE | 0 | 73 | 1 | | 0 | 42 | 0 | 1 | 115 | 2 |
| C | MEYER NOEMIE | 1 | | 0 | 63 | 1 | 71 | 0 | 2 | 134 | 3 |

| Cible 10 | | Match 1 | | Match 2 | | Match 3 | | Totaux | | | |
|----------|-------------------|----------|-------|----------|-------|----------|-------|--------|----------|-------|------------|
| Poule B | | Résultat | Score | Résultat | Score | Résultat | Score | Bonus | Résultat | Score | Classement |
| A | DURRENBERGER INES | 1 | 66 | 1 | 82 | 1 | | 1 | 4 | 148 | 1 |
| B | GASCHY FANNY | 0 | 64 | 1 | | 1 | 62 | 0 | 2 | 126 | 2 |
| C | COUDRIET LAURANE | 1 | | 0 | 36 | 0 | 38 | 0 | 1 | 74 | 3 |

| Cible 11 | | Match 1 | | Match 2 | | Match 3 | | Totaux | | | |
|----------|--------------------|----------|-------|----------|-------|----------|-------|--------|----------|-------|------------|
| Poule C | | Résultat | Score | Résultat | Score | Résultat | Score | Bonus | Résultat | Score | Classement |
| A | LABBE MARION | 1 | 66 | 1 | 78 | 1 | | 1 | 4 | 144 | 1 |
| B | CUVILLIER AMANDINE | 0 | 64 | 1 | | 1 | 87 | 1 | 3 | 151 | 2 |
| C | GUINCHARD EMILIE | 1 | | 0 | 42 | 0 | 35 | 0 | 1 | 77 | 3 |

| Cible 12 | | Match 1 | | Match 2 | | Match 3 | | Totaux | | | |
|----------|--------------------|----------|-------|----------|-------|----------|-------|--------|----------|-------|------------|
| Poule D | | Résultat | Score | Résultat | Score | Résultat | Score | Bonus | Résultat | Score | Classement |
| A | FACANAT JULIETTE | 1 | 76 | 1 | 70 | 1 | | 1 | 4 | 146 | 1 |
| B | KENNER AUDREY | 0 | 74 | 1 | | 1 | 68 | 1 | 3 | 142 | 2 |
| C | PERREAU ANTOINETTE | 1 | | 0 | 9 | 0 | 39 | 0 | 1 | 48 | 3 |

| | | Match 1 | | Match 2 | | Match 3 | |
|----|--|---------|---|---------|---|---------|---|
| AB | | A | B | A | C | B | C |
| CD | | C | | B | | A | |

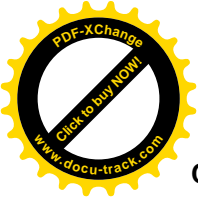

Cadets et Juniors Hommes Classiques

| Cible 13 | | Match 1 | | Match 2 | | Match 3 | | Totaux | | | |
|----------|------------------|----------|-------|----------|-------|----------|-------|--------|----------|-------|------------|
| Poule A | | Résultat | Score | Résultat | Score | Résultat | Score | Bonus | Résultat | Score | Classement |
| A | THIEBAUT MATHIEU | 1 | 86 | 1 | 86 | 1 | 101 | 1 | 4 | 273 | 1 |
| B | BOILEAU JULIEN | 0 | 63 | 1 | 86 | 0 | 80 | 1 | 2 | 229 | 3 |
| C | COLLIGNON DAVID | 1 | 79 | 0 | 77 | 1 | 84 | 0 | 2 | 240 | 2 |
| D | HUSSER FREDERIC | 0 | 16 | 0 | 39 | 0 | 28 | 0 | 0 | 83 | 4 |

| Cible 14 | | Match 1 | | Match 2 | | Match 3 | | Totaux | | | |
|----------|------------------|----------|-------|----------|-------|----------|-------|--------|----------|-------|------------|
| Poule B | | Résultat | Score | Résultat | Score | Résultat | Score | Bonus | Résultat | Score | Classement |
| A | KETTERER HUGO | 1 | 98 | 1 | 99 | 1 | 102 | 1 | 4 | 299 | 1 |
| B | LAEMMEL LEO | 0 | 83 | 1 | 81 | 0 | 75 | 1 | 2 | 239 | 2 |
| C | KILLOFFER MICHEL | 1 | 67 | 0 | 84 | 1 | 77 | 0 | 2 | 228 | 3 |
| D | MATHIEU JEREMIE | 0 | 39 | 0 | 52 | 0 | 68 | 0 | 0 | 159 | 4 |

| Cible 15 | | Match 1 | | Match 2 | | Match 3 | | Totaux | | | |
|----------|------------------|----------|-------|----------|-------|----------|-------|--------|----------|-------|------------|
| Poule C | | Résultat | Score | Résultat | Score | Résultat | Score | Bonus | Résultat | Score | Classement |
| A | BENEDIC JOFFREY | 1 | 102 | 1 | 103 | 1 | 97 | 1 | 4 | 302 | 1 |
| B | DANTEC CORENTIN | 0 | 79 | 1 | 89 | 1 | 81 | 1 | 3 | 249 | 2 |
| C | BEVIERE AURELIEN | 1 | 64 | 0 | 53 | 0 | 59 | 0 | 1 | 176 | 3 |
| D | LEROUX DUNCAN | 0 | 64 | 0 | 38 | 0 | 40 | 0 | 0 | 142 | 4 |

| Cible 16 | | Match 1 | | Match 2 | | Match 3 | | Totaux | | | |
|----------|------------------|----------|-------|----------|-------|----------|-------|--------|----------|-------|------------|
| Poule D | | Résultat | Score | Résultat | Score | Résultat | Score | Bonus | Résultat | Score | Classement |
| A | GOUJON LOIK | 0 | 70 | 1 | 86 | 1 | 90 | 1 | 3 | 246 | 1 |
| B | SCANDONE ANTHONY | 1 | 76 | 0 | 61 | 0 | 75 | 1 | 2 | 212 | 3 |
| C | GERARD GUILLAUME | 1 | 81 | 0 | 83 | 1 | 75 | 0 | 2 | 239 | 2 |
| D | ROMANO ANTONIN | 0 | 60 | 1 | 61 | 0 | 54 | 0 | 1 | 175 | 4 |

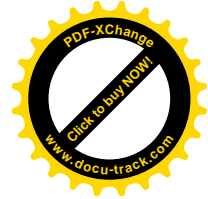

| Cible 17 | | Match 1 | | Match 2 | | Match 3 | | Totaux | | | Classement |
|----------|-----------------|----------|-------|----------|-------|----------|-------|--------|----------|-------|------------|
| Poule E | | Résultat | Score | Résultat | Score | Résultat | Score | Bonus | Résultat | Score | |
| A | SCHMITT ESTEBAN | 1 | 88 | 1 | 74 | 1 | 80 | 1 | 4 | 242 | 1 |
| B | CASERY ALAN | 0 | 80 | 0 | 54 | 0 | 74 | 1 | 1 | 208 | 3 |
| C | MUNSCH PHILIPPE | 1 | 66 | 0 | 73 | 1 | 83 | 0 | 2 | 222 | 2 |
| D | VUILLERMOZ ABEL | 0 | 63 | 1 | 61 | 0 | 63 | 0 | 1 | 187 | 4 |

| Cible 18 | | Match 1 | | Match 2 | | Match 3 | | Totaux | | | Classement |
|----------|------------------|----------|-------|----------|-------|----------|-------|--------|----------|-------|------------|
| Poule F | | Résultat | Score | Résultat | Score | Résultat | Score | Bonus | Résultat | Score | |
| A | JOUBERT VALENTIN | 1 | 76 | 1 | 89 | 1 | 100 | 1 | 4 | 265 | 1 |
| B | BLANCO ROMAIN | 0 | 76 | 1 | 77 | 1 | 82 | 1 | 3 | 235 | 2 |
| C | FLOQUET NICOLAS | 0 | 63 | 0 | 60 | 0 | 77 | 0 | 0 | 200 | 4 |
| D | REINHARDT GILLOU | 1 | 74 | 0 | 52 | 0 | 70 | 0 | 1 | 196 | 3 |

| Cible 19 | | Match 1 | | Match 2 | | Match 3 | | Totaux | | | Classement |
|----------|------------------|----------|-------|----------|-------|----------|-------|--------|----------|-------|------------|
| Poule G | | Résultat | Score | Résultat | Score | Résultat | Score | Bonus | Résultat | Score | |
| A | MATHEY ROBIN | 1 | 78 | 1 | 78 | 1 | 83 | 1 | 4 | 239 | 1 |
| B | LOHR QUENTIN | 0 | 69 | 1 | 84 | 1 | 83 | 1 | 3 | 236 | 2 |
| C | LEROY FLORENT | 1 | 75 | 0 | 60 | 0 | 77 | 0 | 1 | 212 | 3 |
| D | LEPAGE ALEXANDRE | 0 | 32 | 0 | 34 | 0 | 68 | 0 | 0 | 134 | 4 |

| Cible 20 | | Match 1 | | Match 2 | | Match 3 | | Totaux | | | Classement |
|----------|--------------------|----------|-------|----------|-------|----------|-------|--------|----------|-------|------------|
| Poule H | | Résultat | Score | Résultat | Score | Résultat | Score | Bonus | Résultat | Score | |
| A | KETTERER THIBAULT | 1 | 78 | 1 | 71 | 1 | 98 | 1 | 4 | 247 | 1 |
| B | MARTOUZET AUGUSTIN | 0 | 78 | 1 | 70 | 1 | 86 | 1 | 3 | 234 | 2 |
| C | BRAULT ROMAIN | 0 | 70 | 0 | 54 | 0 | 46 | 0 | 0 | 170 | 4 |
| D | BOESCHLIN NICOLAS | 1 | 75 | 0 | 52 | 0 | 57 | 0 | 1 | 184 | 3 |

| | Match 1 | | Match 2 | | Match 3 | |
|----|---------|---|---------|---|---------|---|
| AB | A | B | A | C | A | D |
| CD | C | D | B | D | B | C |



Juniors Hommes Poulies

| Cible 21 | | Match 1 | | Match 2 | | Match 3 | | Match 4 | | Match 5 | | Totaux | | | |
|----------|-----------------------|---------|----------|---------|----------|---------|----------|---------|----------|---------|-------|----------|-------|------------|---|
| Poule A | Résultat | Score | Résultat | Score | Résultat | Score | Résultat | Score | Résultat | Score | Bonus | Résultat | Score | Classement | |
| A | FARAH MOHAMED | 1 | 100 | 1 | 105 | 1 | 101 | 1 | 101 | 1 | | 1 | 6 | 407 | 1 |
| B | LUX CHRISTOPHE | 0 | 73 | 1 | 101 | 1 | | 0 | 80 | 1 | 86 | 1 | 4 | 340 | 2 |
| C | CHRIST-BERTRAND JOHAN | 0 | 72 | 0 | 82 | 1 | 75 | 1 | | 0 | 86 | 0 | 2 | 315 | 4 |
| D | JAMEAU ALEXANDRE | 1 | 75 | 1 | | 0 | 96 | 1 | 81 | 1 | 78 | 0 | 4 | 330 | 3 |
| E | MULLER PIERRE | 1 | | 0 | 63 | 0 | 66 | 0 | 81 | 0 | 74 | 0 | 1 | 284 | 5 |

| | Match 1 | | Match 2 | | Match 3 | | Match 4 | | Match 5 | |
|----|---------|---|---------|---|---------|---|---------|---|---------|---|
| AB | A | B | A | C | A | D | A | E | B | C |
| CD | C | D | B | E | C | E | B | D | D | E |
| | E | | D | | B | | C | | A | |



Minimes Mixtes Classique

| Cible 3 | | Match 1 | | Match 2 | | Match 3 | | Totaux | | | |
|---------|--------------------|----------|-------|----------|-------|----------|-------|--------|----------|-------|------------|
| Poule A | | Résultat | Score | Résultat | Score | Résultat | Score | Bonus | Résultat | Score | Classement |
| A | KLEIN LORRAINE | 0 | 41 | 0 | 45 | 1 | 59 | 1 | 2 | 145 | 3 |
| B | BERTHOLD CLEMENCE | 1 | 69 | 1 | 47 | 1 | 65 | 1 | 4 | 181 | 1 |
| C | JOSSERAND JONATHAN | 1 | 70 | 1 | 67 | 0 | 47 | 0 | 2 | 184 | 2 |
| D | POTDEVIN JULIEN | 0 | 61 | 0 | 44 | 0 | 53 | 0 | 0 | 158 | 4 |

| | Match 1 | | Match 2 | | Match 3 | |
|----|---------|---|---------|---|---------|---|
| AB | A | B | A | C | A | D |
| CD | C | D | B | D | B | C |

Benjamins Hommes Classique

| Cible 2 | | Match 1 | | Match 2 | | Match 3 | | Totaux | | | |
|---------|-----------------------|----------|-------|----------|-------|----------|-------|--------|----------|-------|------------|
| Poule A | | Résultat | Score | Résultat | Score | Résultat | Score | Bonus | Résultat | Score | Classement |
| A | TOMBUL ALEXIS | 0 | 93 | 1 | 100 | 1 | 100 | 1 | 3 | 293 | 2 |
| B | TOMBUL FLORIAN | 1 | 95 | 1 | 91 | 1 | 104 | 1 | 4 | 290 | 1 |
| C | GERHARDT SYLVAIN | 1 | 97 | 0 | 96 | 0 | 90 | 0 | 1 | 283 | 3 |
| D | HATTENBERGER GREGOIRE | 0 | 86 | 0 | 80 | 0 | 87 | 0 | 0 | 253 | 4 |

| | Match 1 | | Match 2 | | Match 3 | |
|----|---------|---|---------|---|---------|---|
| AB | A | B | A | C | A | D |
| CD | C | D | B | D | B | C |

Benjamines Dames Classique

| Cible 1 | | Match 1 | | Match 2 | | Match 3 | | Totaux | | | |
|---------|---------------|----------|-------|----------|-------|----------|-------|--------|----------|-------|------------|
| Poule A | | Résultat | Score | Résultat | Score | Résultat | Score | Bonus | Résultat | Score | Classement |
| A | MEYER PERRINE | 0 | 94 | 0 | 68 | 1 | | 1 | 2 | 162 | 3 |
| B | MAIRE MARINE | 1 | 98 | 1 | | 1 | 98 | 0 | 3 | 196 | 1 |
| C | FISHER NADEGE | 1 | | 1 | 84 | 0 | 94 | 0 | 2 | 178 | 2 |

| | Match 1 | | Match 2 | | Match 3 | |
|----|---------|---|---------|---|---------|---|
| AB | A | B | A | C | B | C |
| CD | C | | B | | A | |

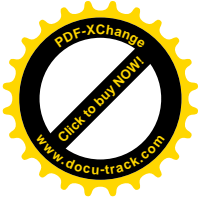
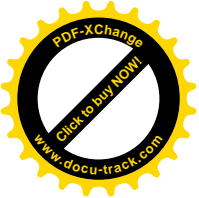

Minime Fille Classique

Finale

| | | | |
|----------------------|--|----------------------|-------------|
| Cible 5A | <table border="1"><tr><td>THOMAS SOLENE</td><td>2ème 96</td></tr></table> | THOMAS SOLENE | 2ème 96 |
| THOMAS SOLENE | 2ème 96 | | |
| Cible 5B | <table border="1"><tr><td>SCHEPPERS MADISON</td><td>1ère 100</td></tr></table> | SCHEPPERS MADISON | 1ère 100 |
| SCHEPPERS MADISON | 1ère 100 | | |

Petite Finale

| | | | |
|-------------------|--|-------------------|-------------|
| Cible 6A | <table border="1"><tr><td>MILLOT ELODIE</td><td>3ème 102</td></tr></table> | MILLOT ELODIE | 3ème 102 |
| MILLOT ELODIE | 3ème 102 | | |
| Cible 6B | <table border="1"><tr><td>SIXTO VICTORIA</td><td>4ème 75</td></tr></table> | SIXTO VICTORIA | 4ème 75 |
| SIXTO VICTORIA | 4ème 75 | | |

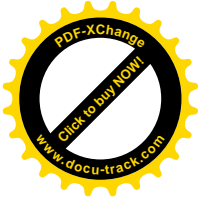
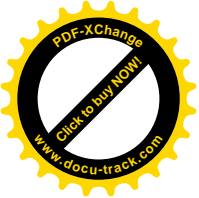

Cadettes et Juniors Femmes Classiques

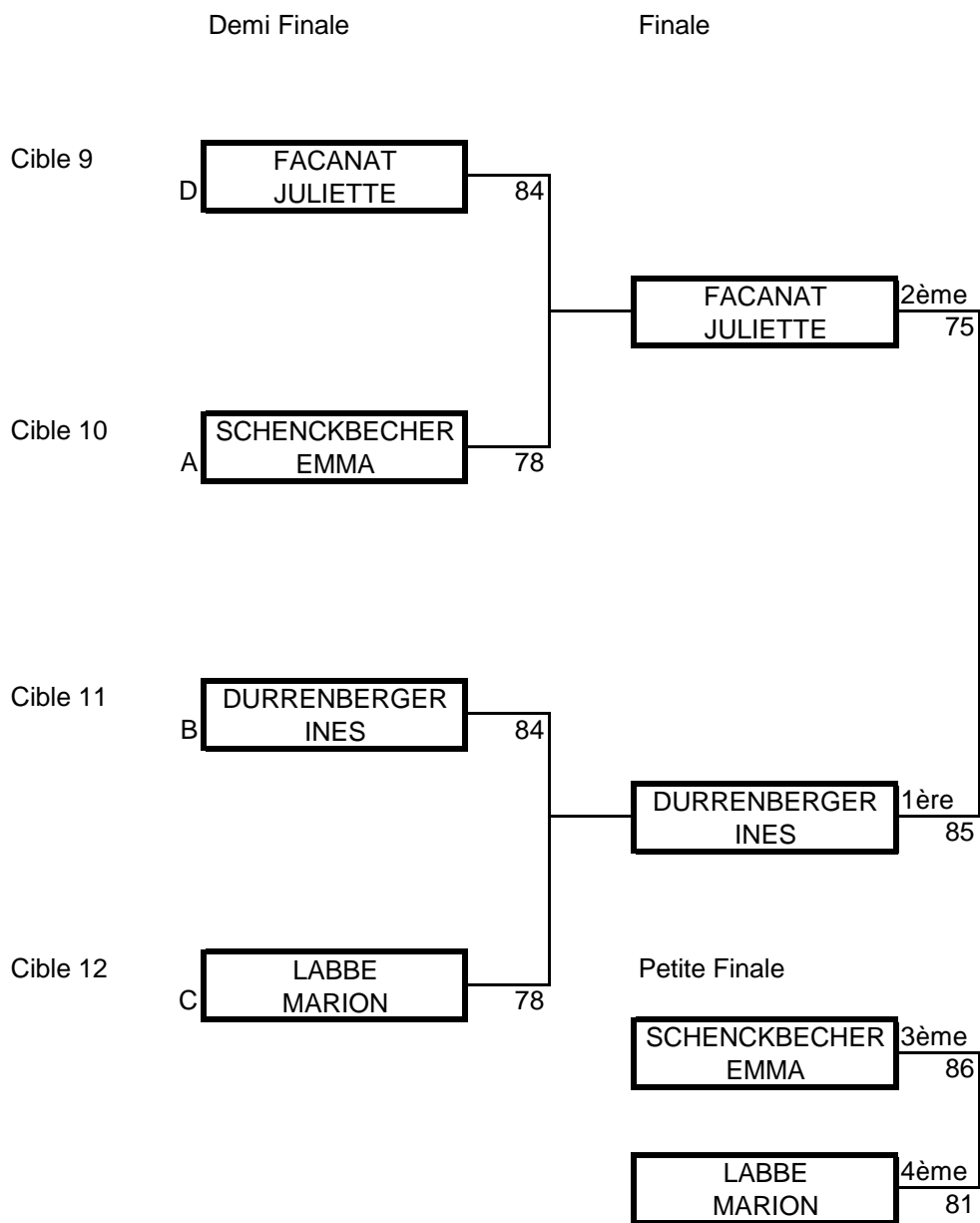

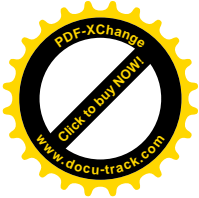
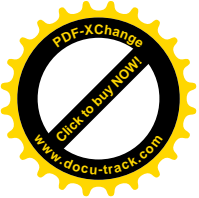

Cadets et Juniors Hommes Classiques

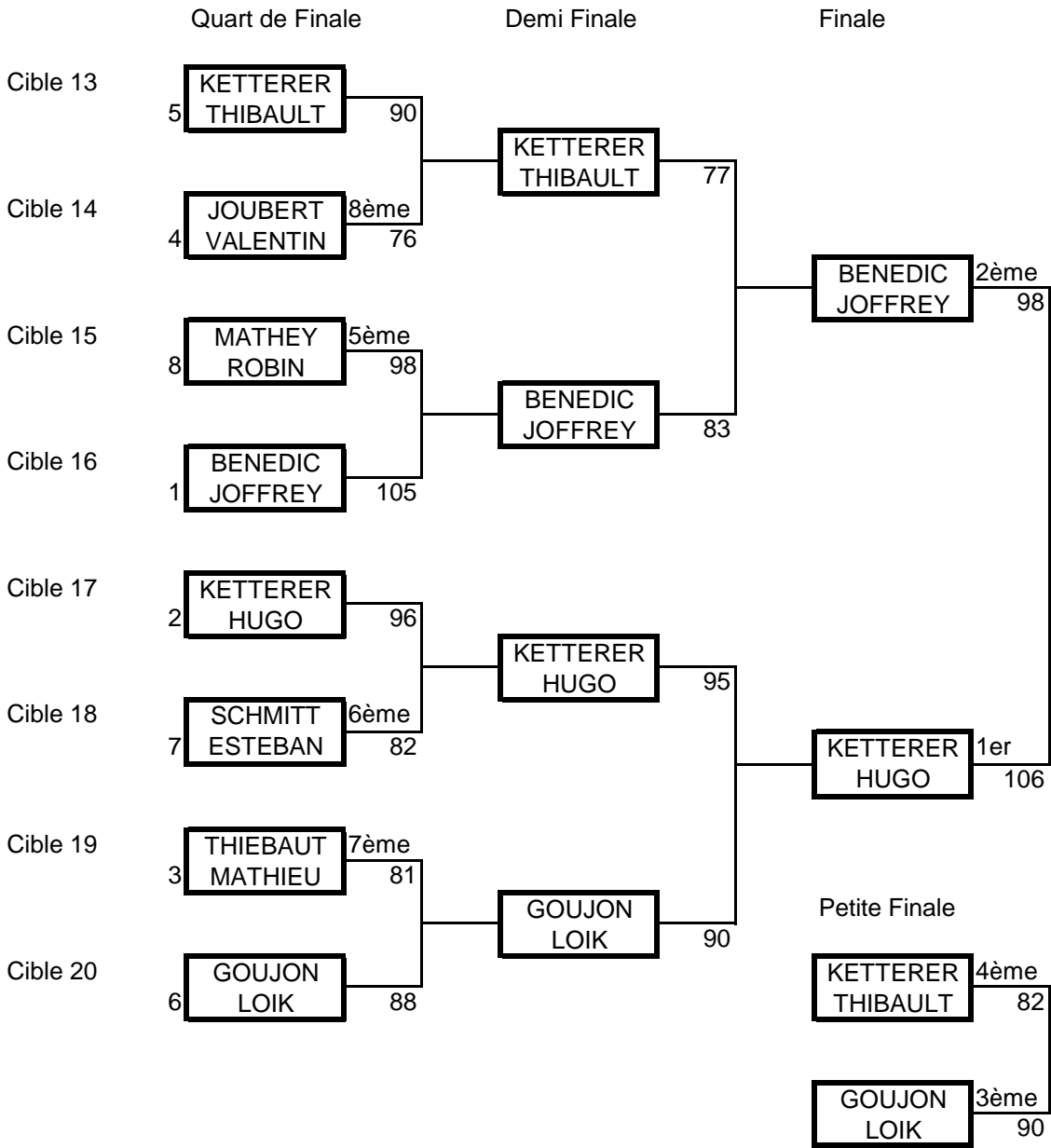

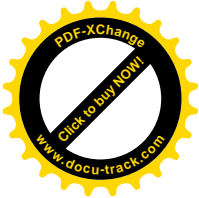
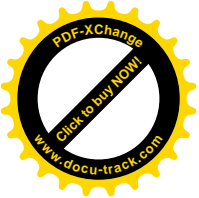

Minime Homme Classique

